

Package

SOT-89

Package Outline Dimensions (unit: mm)

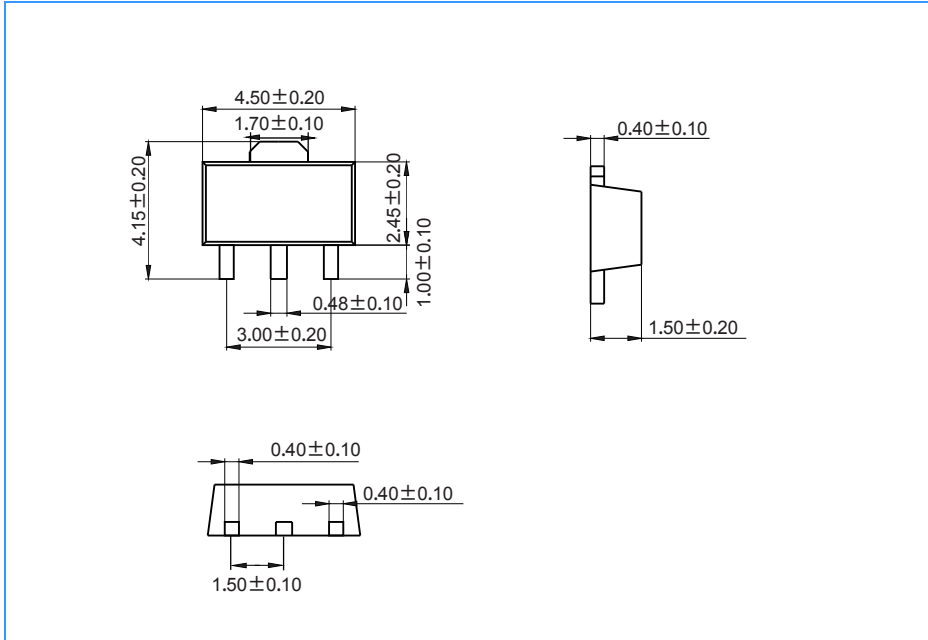

Mounting Pad Layout (unit: mm)

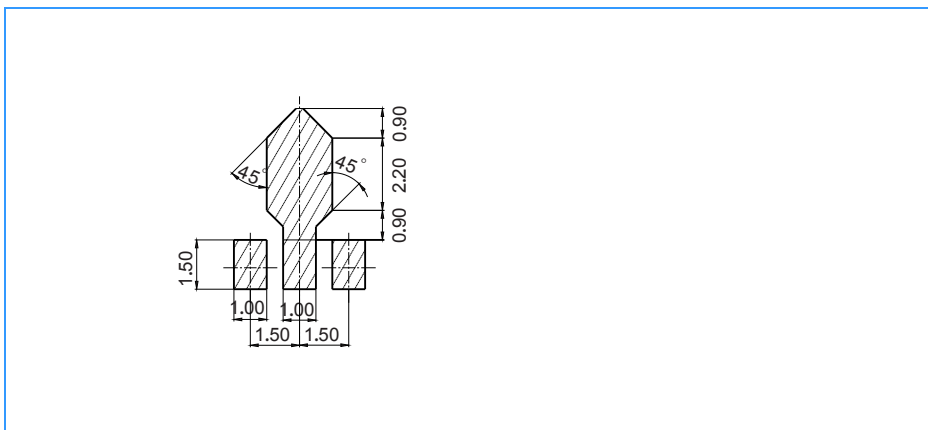

Packing Information

Package	Shipping Quantity
SOT-89	1000 pcs / Tape & Reel